

Sottile 2D (2x2 or 2x4)

L2D Series

Project Name:	
Type:	Date:
Catalog #:	

Description:

The Nulite Sottile [so-tee-lay] 2D series is a new fully luminous architectural recessed luminaire. This cost effective, energy efficient luminaire series provides soft ambient illumination.

Specifications:

Construction: Die formed cold rolled steel housing. Housing finish is white baked enamel. Optional die formed 20 gauge cold rolled steel housing and powder coated white paint after fabrication. Access plate allows for easy wiring without opening luminaire.

Reflector / Ballast: Ballast cover/pan is finished with high reflectance white paint. Standard electronic, Class P, ballast. Universal (UNV) voltage is from 120 - 277V.

Shielding: Extruded 3-piece smooth frosted acrylic diffusers. Spring tension shift-and-remove center diffuser for convenient lamp maintenance. Optional center diffusers: internal radial white baffle with clear linear prism, frosted linear prism, clear smooth with round perf overlay and white metal perf with inlay.

Lamping: 1, 2 or 3 lamp cross-section. 3 lamp not available for long twin tube and consult factory for T5HO. Luminaire can be ordered with lamps, consult factory.

Mounting: Acoustical grid. Non-IC rated. Optional inaccessible ceiling or surface mounting.

Labels: UL / cUL listed. Optional Damp location.

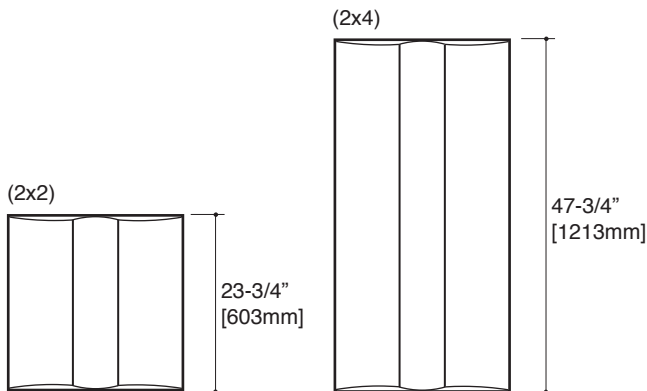
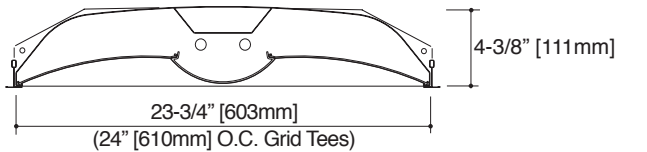

Ordering Information

Sample: L2D-228T5-UNV-PSN-IRB-DL

Series	Lamp	Wattage	Voltage	Ballast	Options	
L2D						
(Nom. 2' width)	1 2 3 ¹	(2' Nom. Length) 14T5 24T5HO 17T8 40FT 50FT 55FT (4' Nom. Length) 28T5 54T5HO 32T8	UNV 120 277 347 ²	T8 Options IS (Standard) Instant Start PS Program Start HEIS High Efficiency Instant Start HEPS High Efficiency Program Start T5/T5HO/FT PS (Standard) Program Start HEPS ³ High Efficiency Program Start	Ballast Factor N Normal (Standard) L Low H High Ballast Factor N Normal	QS ⁴ Quick Ship 5 day (100 max) / 10 day (200 max) IRB Internal Radial White Baffle with Clear Linear Prism Center Diffuser RFD Frosted Linear Prism Center Diffuser RPO Round Perforated Overlay Center Diffuser MPF White Metal Perforated Center w/ Inlay MLS Multi-Level Switching (3-Lamp Only) EM ⁵ Emergency Battery Pack AIR ⁶ Air Return GLR Fusing DL Damp Location FLG Flange Kit CP Chicago Plenum SIC Seismic Clips SF Surface Mount LRC Lens Retainer Clip 20PAF 20 ga. CRS / Paint After Fabrication DSR Daylight Sensor - Remote FLEX3 6' of Flex, 3-wire FLEX4 6' of Flex, 4-wire HP28 High Performance for (2) 28W T5 Only
				All Lamp Dimming Options DIM ³ Dimming SD ³ Step Dimming		

Notes:

- Not available for Long Twin Tube. Consult factory for T5HO.
- Not available with EM option.
- Consult factory.
- Highlighted options are available for Quick Ship. Order must be marked "QS". Order quantities of (1 - 100) will ship in 5 day; order quantities of (101 - 200) will ship in 10 days. Consult factory for Quick Ship policies.
- Specific voltage must be ordered for this option. Some EM's may require "doghouse" or remote mounting, consult factory.
- Not all options available with Air Return, consult factory. Seismic clips are not available with this option.

Center Diffuser Options

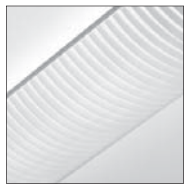

IRB



RFD



RPO

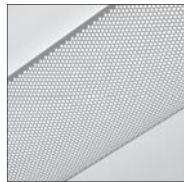

MPF

Grid Ceiling Mounting Details

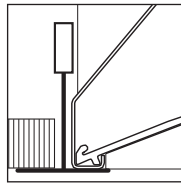

1" Tee Grid

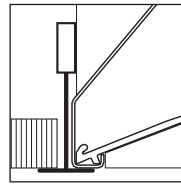

9/16" Tee Grid

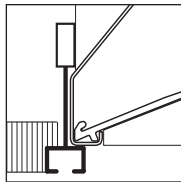

Screw Slot Grid

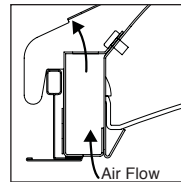

**AIR Option - Slotted
Black Side Rails**

Surface Mounting



SF Option

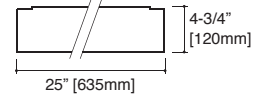

Photometric Curves

Cat. # L2D-228T5... RFD-HP28

Initial lamp lumens - 5200
Efficiency - 90.6%

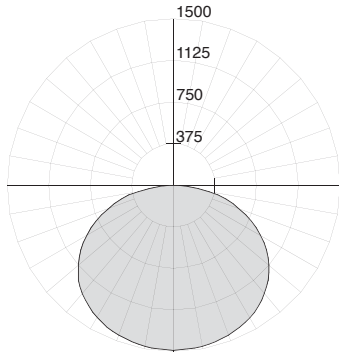

Cat. # L2D-128T5...

Initial lamp lumens - 2600
Efficiency - 85.7%

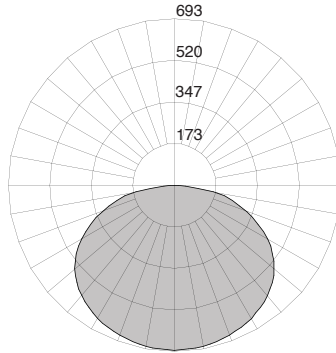

Cat. # L2D-128T5... RCD

Initial lamp lumens - 2600
Efficiency - 86.5%

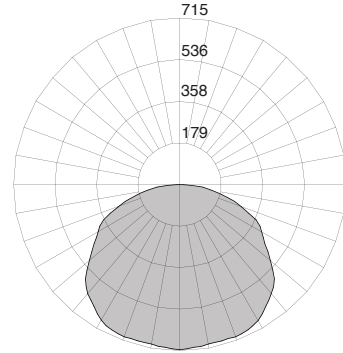

Cat. # L2D-128T5... RFD

Initial lamp lumens - 2600
Efficiency - 86.0%

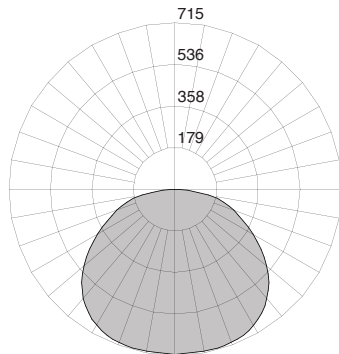

Cat. # L2D-228T5...

Initial lamp lumens - 5200
Efficiency - 88.2%

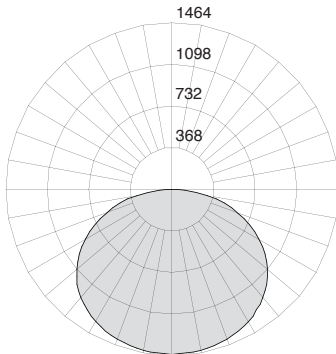

Cat. # L2D-328T5...

Initial lamp lumens - 7800
Efficiency - 80.8%

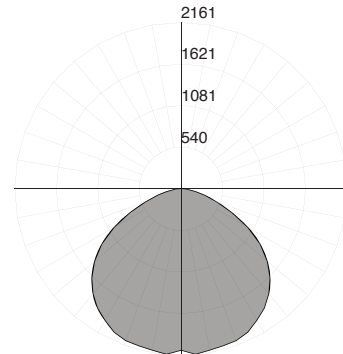

Specifications and dimensions are subject to change without notification.