

PIXIE PXP3-R

Linear Pendant

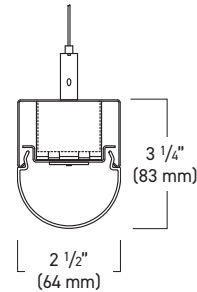

- Linear pendant lighting for general illumination of commercial, retail, office, and warehouse spaces.
- Die formed 20 gauge cold rolled steel housing. Finish is white polyester powder coat paint after fabrication. Optional aluminum (painted white) or stainless steel (natural finish) housing.
- Distributed LED array in a wide variety of lumen output packages. LED color is available in 3000K, 3500K or 4000K with a CRI of 80 or 90. 5000K available with a CRI of 80. Custom outputs are available. Module is replaceable. L90≥100,000 hrs.
- Standard constant current electronic driver with 0-10V dimming input; dimming range from 100% down to 1%. Optional drivers are available.
- Extruded frosted acrylic snap-on lens.

PXP3-R
100% Direct Light Distribution

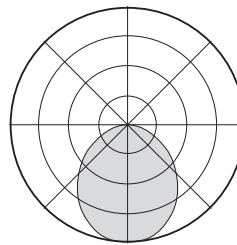

Row Lengths

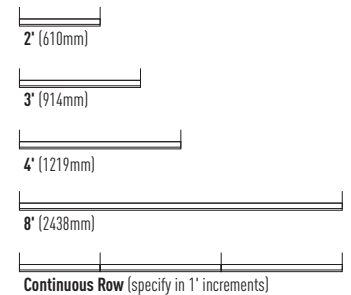

ORDERING INFORMATION

SAMPLE NUMBER: PXP3-R-05L35-U-D-W-SR/48-4

PXP3	R			
SERIES	DIRECT SHIELDING	LUMEN PACKAGE ¹	CRI/ CCT	BATTERY OPTIONS ³
PXP3 - Pixie 3" tall integral pendant	R - Round Lens	03 - ~300 lm/ft 05 - ~500 lm/ft 06 - ~600 lm/ft 09 - ~900 lm/ft 10 - ~1000 lm/ft XX²	L30 - 80 CRI, 3000K L35 - 80 CRI, 3500K L40 - 80 CRI, 4000K L50 - 80 CRI, 5000K H30 - 90 CRI, 3000K H35 - 90 CRI, 3500K H40 - 90 CRI, 4000K	B5 - 5W Battery Pack B7 - 7W Battery Pack B10 - 10W Battery Pack B12 - 12W Battery Pack CEC - CEC Compliant (10W Battery Pack)
Notes:				
1. Nominal lumen output for 3500K				
2. Consult for custom lumen package				
3. In order to have a battery, luminaire is required to be >4'. Consult factory for additional options				
4. Consult factory for specifications and custom dimming options. See page 2 for additional information				
5. Consult factory for additional options				
6. Continuous rows installed via quick through wiring. Specify run length in 1' increments				
7. Not available in 2 ft. lengths				
8. Specify 1 - 120 volt or 2 - 277 volt				

VOLTAGE	DRIVER ⁴	LUMINAIRE FINISH	MOUNTING / SUSPENSION LENGTH (IN INCHES)	LENGTH	OPTIONS ⁵
U - Universal 1 - 120 volt 2 - 277 volt	Dimming 0-10V D - Dims to 1% (Standard) DO - Dims to 1%, fade to off DO2 - Eldoled Solodrive, dims to 0% DALI Dimming ELE - Eldoled Ecodrive, dims to 1% ELS - Eldoled Solodrive, dims to 0%	W - White (Standard) AL - Aluminum Housing (Painted White) SS - Stainless Steel Housing (Natural) CC⁵ - Custom Color	AC to Grid Ceiling T1 / 48 T1 / 120 T9 / 48 T9 / 120 TS / 48 TS / 120	AC to Structure Ceiling SR / 48 SR / 120	2 - 2 ft 3 - 3 ft 4 - 4 ft 8 - 8 ft XX² - x ft DS - Daylight sensor OS - Occupancy sensor GTD⁶ - Generator transfer device ETS⁶ - Electronic transfer switch GLR - Fusing LKO - Less knock out FLEX5 - 6' of flex, 5-wire

LIGHTING CONTROL

Nulite provides flexibility in meeting the needs of each project by easily integrating with several manufacturers for lighting control options.

0-10V: A non-directional dimming system. The control system tells the LED driver what to do and it adjusts according to the voltage on the control circuit.

DALI: Digital Addressable Lighting Interface is a simple two-wire control connection that goes to each fixture to form the control network. It allows LED drivers to be controlled independently from lighting control circuits.

Solution	Manufacturer	Prefix	Series	Dim Level	Quantity of Wires	Dim to Dark (Smooth)	Fade to Off
Dimming 0-10V							
D	Variable			1%	2		
D0	Variable			0%	2		X
D02	eldoLed		SOLOdrive	0%	2	X	
DALI Dimming							
ELE	eldoLed		ECOdrive	1%	2	X	
ELS	eldoLed		SOLOdrive	0%	2	X	
Lutron Dimming							
L11	Lutron	PEQ*	Hi-Lume Premier	0.1%	2	X	
L12	Lutron	LTEA	Hi-lume™ 2-Wire 120V forward phase	1%	No Control Wires - Uses Hot		
L15	Lutron	LDE1	Hi-lume™ - H Series	1%	2	X	
L16	Lutron	LDE5	5-Series	5%	2		

*Maximum lumen package is 03

INTEGRAL DRIVER PENDANT INSTALLATION DETAILS

AC TO GRID CEILING (Option T1, T9 OR TS)

Power Feed

Non-Power Feed

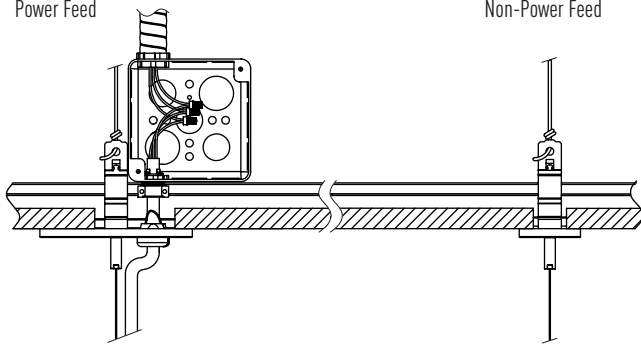

AC TO STRUCTURE CEILING (Option SR)

Power Feed

Non-Power Feed

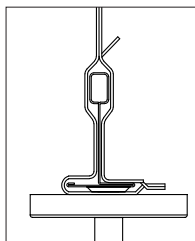
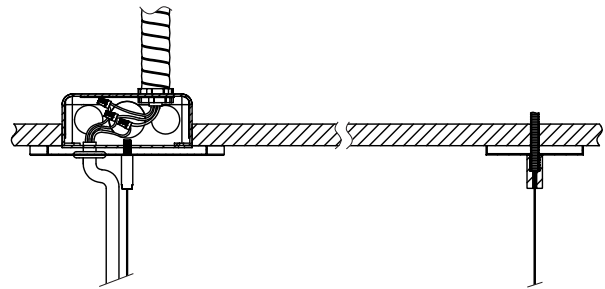

T1
15/16" Grid

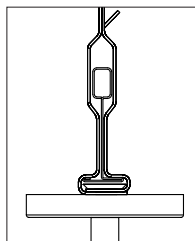

T9
9/16" Grid

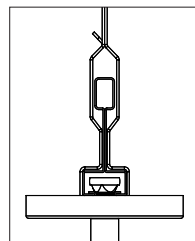

TS
Slot Grid

PRODUCT DETAILS

LIGHT SOURCE LED custom linear array is mounted with quick-connect wiring to facilitate service. Five lumen packages are available (03, 05, 06, 09, and 10). Custom outputs are available. All luminaire configurations are tested in accordance with IESNA-LM 80.

DRIVER Standard constant current integral electronic driver with 0-10V dimming input; dimming range from 100% down to 1%. Dims to 0%, DALI are available. Universal (U), 120 volt (1) and 277 volt (2).

OPTIONAL DALI Digital Addressable Lighting Interface is a simple two-wire control connection that goes to each fixture to form the control network. DALI enables dimmable transformers, relay modules, emergency fittings, and controllers from different manufacturers to be mixed and matched into a single control system, allowing LED drivers to be controlled independently from lighting control circuits.

OPTIONAL BATTERY OPTIONS Recyclable Ni-Cad battery pack, battery run time is 90 minutes. 5W, 7W, 10W, or 12W battery packs are available. Recharge time of 24 hours. Battery option not available in less than 4' lengths.

MOUNTING Designed to install into grid (T1, T9 or TS clips) and structure ceilings. Aircraft cable suspended, individual mount or continuous rows via quick through wiring. Refer to installation instructions for appropriate ceiling detail.

WARRANTY 5-year limited warranty on LED and driver from date of shipment. Refer to the full warranty details on www.nulite-lighting.com.

LUMINAIRE LENGTH Lengths of 2', 3', 4', and 8' lengths. 8-foot maximum section length.

WEIGHT ~1.75 lbs/ft.

APPROVALS ETL listed, conforms to UL Standard 1598 / 8750 and CSA Standard C22.2, indoor dry/dam locations.

INDEPENDENT TESTING

IESNA LM79 - Testing method for the Electrical and Photometric Measurements of Solid State Lighting on the complete system, such as luminous flux, electrical power, luminous intensity distribution, and various properties of chromaticity.

IESNA LM80 - Testing method for measuring lumen maintenance of LED light sources, applies to the LED package, array or module alone, not the complete system.