

REGOLO 1
RP13
 Bi-Direct

Pendant / Baffle
 Integral Driver

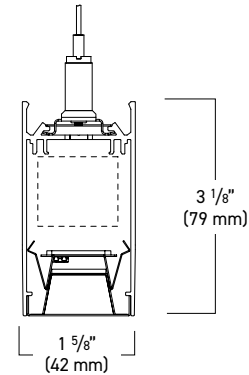

- Micro-scale functional pendant luminaire that provides unlimited lighting possibilities for creative design.
- Precision cut extruded aluminum housing. Housing standard finish is electrostatically applied textured white powder coat paint. Optional silver, black, or custom color paint finishes.
- Long-life distributed LED array in a variety of lumen output packages. LED color is available in 3000K, 3500K or 4000K with a CRI of 80 or 90. Custom outputs are available. Module is replaceable. L90>100,000 hours.
- Baffle provides additional shielding to reduce glare. Constructed with precision cut die-form sheet aluminum housing. The formed blades consist of 5/8" deep blades with 1 1/2" of spacing. Housing standard finish is electrostatically applied textured powder coat. Available in white or black.

RP13-B (White Baffle)
 36% Downlight / 64% Uplight

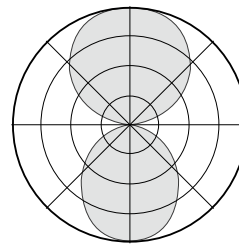

Light Output and Energy Consumption*

Light Level	lm/ft	Watts/ft	Efficacy
03	509.8	5.1	99.0
05	989.8	9.4	105.0
08	1441.3	14.0	103.0

Lumen output may vary. 3500K / 80 CRI used for above results.

ORDERING INFORMATION

SAMPLE NUMBER: RP13-B-BW-05L35-1C-U-D-WW-T1/120-4

RP13-B						
SERIES	DIRECT SHIELDING ¹	INDIRECT SHIELDING ¹	LUMEN PACKAGE DOWN ²	LUMEN PACKAGE UP ²	CRI/ CCT	CIRCUIT ⁴

RP13-B - Regolo 1.5" wide, 3" tall bi-direct integral pendant	BB - Baffle Black BW - Baffle White	DG - Optional dust guard	03 - 250 lm/ft 05 - 500 lm/ft 08 - 750 lm/ft XX ³	03 - 250 lm/ft 05 - 500 lm/ft 08 - 750 lm/ft 10 - 1000 lm/ft 13 - 1250 lm/ft XX ³	L30 - 80 CRI, 3000K L35 - 80 CRI, 3500K L40 - 80 CRI, 4000K H30 - 90 CRI, 3000K H35 - 90 CRI, 3500K H40 - 90 CRI, 4000K	1C - Single Circuit 1E - Single Circuit with EM Circuit 1B6 - Single Circuit with 6W Battery Pack 1B10 - Single Circuit with 10W Battery Pack 2C - Dual Circuit 2E - Dual Circuit with EM Circuit 2B6 - Dual Circuit with 6W Battery Pack 2B10 - Dual Circuit with 10W Battery Pack
---	--	--------------------------	---	---	--	--

- Notes:**
1. Consult factory for additional options
 2. Nominal lumen output for 3500K, 80 CRI. For lengths <72" with battery, lumen package down and lumen package up are required to be the same
 3. Consult factory for custom lumen package
 4. In order to have a battery circuit or to be a 2-circuit, the luminaire is required to be > 4'. A luminaire with a 2-circuit and battery is required to be > 6'. Consult factory for additional options.
 5. Consult factory for specifications and custom dimming options. See page 2 for manufacturer information.
 6. Specify run length in 2' increment
 7. Specify 1 - 120 volt or 2 - 277 volt

VOLTAGE	DRIVER ⁵		LUMINAIRE FINISH	MOUNTING / SUSPENSION LENGTH (IN INCHES)	LENGTH	OPTIONS ¹
U - Universal 1 - 120 Volt 2 - 277 Volt	Dimming 0-10v D - Dim to 1% (Standard) DO - Dim to 1%, fade to off DO2 - Eldoled Solodrive, dims to 0%	DALI Dimming ELE - Eldoled Ecodrive, dims to 1% ELS - Eldoled Solodrive, dims to 0% Lutron Dimming L11 - Lutron HiLume™ Premier, dims to 0.1% L12 - Lutron HiLume™ 2-Wire 120V Forward Phase, dims to 1% L15 - Lutron HiLume™ H-Series, dims to 1% L16 - Lutron HiLume™ 5-Series, dims to 5%	W - White (Standard) S - Silver B - Black CC ¹ - Custom Color CANOPY FINISH W - White (Standard) B - Black	A/C to Grid Ceiling T1 / 48 T1 / 120 T9 / 48 T9 / 120 TS / 48 TS / 120 A/C to Structure Ceiling GP / 48 GP / 120	2 - 2 ft 4 - 4 ft 6 - 6 ft 8 - 8 ft XX ⁶ - x ft	N - Nightlight DS - Daylight sensor OS - Occupancy sensor GTD ⁷ - Generator transfer device ETS ⁷ - Electronic transfer switch

PHOTOMETRICS

**RP13 WHITE BAFFLE
BI-DIRECT DISTRIBUTION**

Cat# RP13-B-BW-05L35-1C-U-D-W-4

ITL Test #: ITL91205

Total Delivered Lumens: 3959

Input Watts: 37.7

Efficacy: 105 lm/W

36% Downlight

64% Uplight

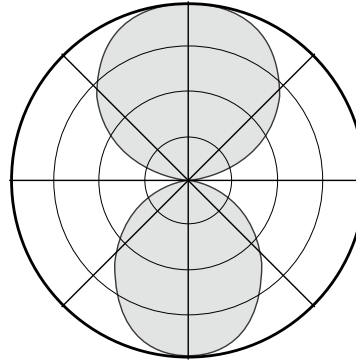

Luminance Data (CD/SQ.M)

Angle in Degrees	Average 0-Deg	Average 45-Deg	Average 90-Deg
45	11771	9338	6844
55	8812	5850	5287
65	4122	4275	4173
75	3241	3241	3241
85	2221	2221	2221

Zonal Lumen Summary

Zone	Lumens	%Fixt
0-30	587	15
0-40	896	23
0-60	1293	33
0-90	1429	36
90-120	488	12
90-130	925	23
90-150	1847	47
90-180	2530	64
0-180	3959	100

LIGHTING CONTROL

Nulite provides flexibility in meeting the needs of each project by easily integrating with several manufacturers for lighting control options.

0-10V: A non-directional dimming system. The control system tells the LED driver what to do and it adjusts according to the voltage on the control circuit.

DALI: Digital Addressable Lighting Interface is a simple two-wire control connection that goes to each fixture to form the control network. It allows LED drivers to be controlled independently from lighting control circuits.

Solution	Manufacturer	Prefix	Series	Dim Level	Quantity of Wires	Dim to Dark (Smooth)	Fade to Off
Dimming 0-10V							
D	Variable			1%	2		
D0	Variable			0%	2		X
D02	eldoLed		SOLOdrive	0%	2	X	
DALI Dimming							
ELE	eldoLed		ECOdrive	1%	2	X	
ELS	eldoLed		SOLOdrive	0%	2	X	
Lutron Dimming							
L11*	Lutron	PEQ	Hi-Lume Premier	0.1%	2	X	
L12	Lutron	LTEA	Hi-lume™ 2-Wire 120V forward phase	1%	No Control Wires - Uses Hot		
L15	Lutron	LDE1	Hi-lume™ - H Series	1%	2	X	
L16	Lutron	LDE5	5-Series	5%	2		

*Maximum lumen package is 03

INTEGRAL DRIVER PENDANT INSTALLATION DETAILS

A/C TO GRID CEILING (OPTION T1, T9 OR TS)

A/C TO STRUCTURE CEILING

Power Feed

Non-Power Feed

Power Feed

Non-Power Feed

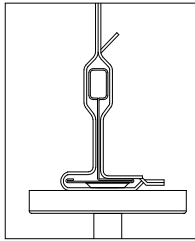
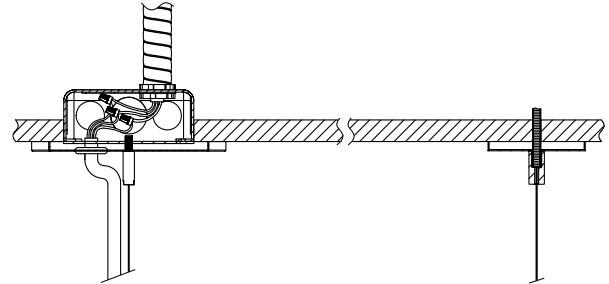
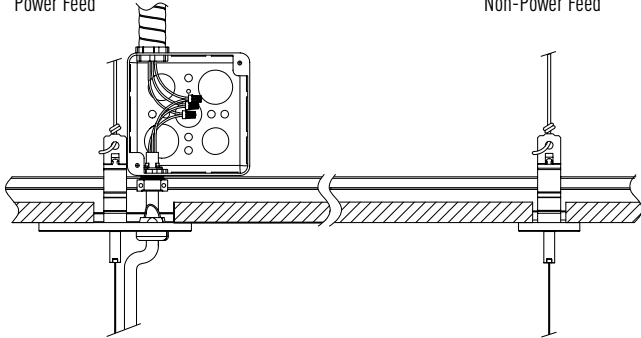

T1
15/16" Grid

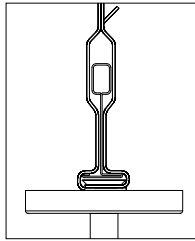

T9
9/16" Grid

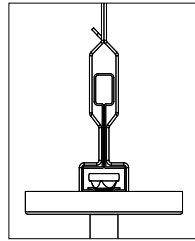

TS
Slot Grid

STANDARD LENGTHS

ORDERING EXAMPLE FOR STANDARD LENGTH

RP14-B-FF-05L35-1C-U-D-W-T148-22'

Lines

For linear individuals and continuous linear runs, specify run lengths in 2' increments.

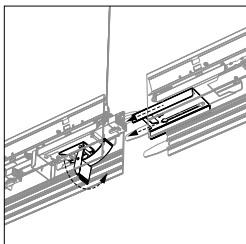
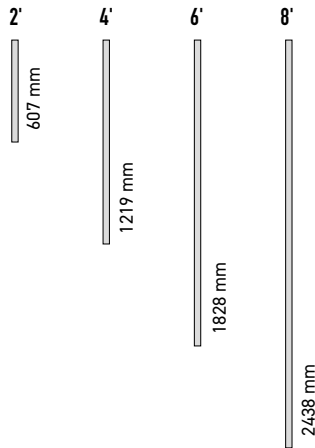

Tool less continuous joining

PRODUCT DETAILS

LIGHT SOURCE LED custom linear array is mounted with quick-connect wiring to facilitate service. A wide array of lumen packages are available. All luminaire configurations tested in accordance with IESNA LM-79. Diodes tested in accordance with IESNA LM-80.

DRIVER Standard constant current integral electronic driver with 0-10V dimming input standard; dimming range from 100% down to 1%. Dims to 0% and DALI are available. Universal (U), 120 volt (1), and 277 volt (2).

OPTIONAL DALI Digital Addressable Lighting Interface is a simple two-wire control connection that goes to each fixture to form the control network. DALI enables dimmable transformers, relay modules, emergency fittings, and controllers from different manufacturers to be mixed and matched into a single control system, allowing LED drivers to be controlled independently from lighting control circuits.

OPTIONAL BATTERY AND EMERGENCY OPTIONS Recyclable Ni-Cad battery pack, battery run time is 90 minutes. Recharge time of 24 hours. 6W or 10W battery packs are available. Total output is determined by exact efficacy of specific configuration multiplied by battery wattage (i.e. RP13-B-BW-05L35-1C-U-D-W-4 with a 10W battery pack is a 1050 battery lumen output). Battery option not available in less than 4' lengths. Entire direct fixture housing is on battery for lengths up to 5'. 4' of direct

fixture is on battery for 6' - 8' housing lengths. For bi-direct fixtures less than 72", the battery will be split equal power for the direct and indirect portions. For bi-direct fixtures 72" and longer, the full power of the battery will power 4' of the direct portion. Emergency or night light circuit available.

SECURE TOOL-FREE JOINING DESIGN A dynamic mechanism that ensures stable positioning, no light leak, and speeds up installation in continuous rows. Constructed with spring steel over center draw latch, 22 gauge thick.

MOUNTING Designed to install into grid (T1, T9 or TS clips), inaccessible, and surface ceilings. Aircraft cable suspended, individual mount or continuous runs. Supplied with 5" (127mm) power and 2" (50.8 mm) non-power canopies. Refer to installation instructions for appropriate ceiling detail.

WARRANTY 5-year limited warranty on LED and driver from date of shipment. Refer to the full warranty details on www.nulite-lighting.com.

LUMINAIRE LENGTH Any length in increments of 2'. Minimum 2' length. Maximum 8' section length. Maximum 50-foot continuous run length per circuit.

WEIGHT ~1.5 lbs/ft.

APPROVALS ETL listed, conforms to UL Standard 1598 / 8750 and CSA Standard C22.2, indoor dry/damp locations.

INDEPENDENT TESTING

IESNA LM79 - Testing method for the Electrical and Photometric Measurements of Solid State Lighting on the complete system, such as luminous flux, electrical power, luminous intensity distribution, and various properties of chromaticity.

IESNA LM80 - Testing method for measuring lumen maintenance of LED light sources, applies to the LED package, array or module alone, not the complete system.